



ZROADZ

DYNAMIC LED MOUNTING SOLUTIONS



2015-2017 DODGE RAM REBEL 1500

Z384551 / Z384551-KIT
REAR BUMPER LED LIGHT MOUNTS

PARTS ARE PATENT PENDING. ALL RIGHTS RESERVED - COPYRIGHT ©2016 - ZROADZ LED, INC.

PARTS INCLUDED

- (1) Driver Light Mount Bracket
- (1) Passenger Light Mount Bracket

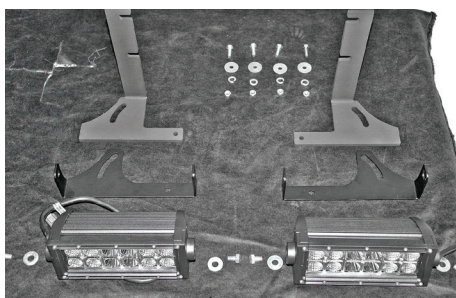

Kit - w/ (2) 6" LED Light Bars

LED LIGHTS INCLUDED

Z384551 - No LED Lights Included

Z384551-KIT - (2) ZROADZ 6" LED Light Bars

* LED Lights include a separate hardware kit.

HARDWARE INCLUDED

Z384551

- (1) - Left Side Rear Hanging Bracket - L
- (1) - Right Side Rear Hanging Bracket - R
- (1) - Universal Left Side Bracket LED Cradle
- (1) - Universal Right Side Bracket LED Cradle
- (4) - M8 x 16mm Button Head Allen Cap
Stainless Steel Bolts
- (4) - M8 Stainless Steel Hex Nuts
- (4) - 5/16" Flat Washers Black

Z384551-KIT

- (1) - Left Side Rear Hanging Bracket - L
- (1) - Right Side Rear Hanging Bracket - R
- (1) - Universal Left Side Bracket LED Cradle
- (1) - Universal Right Side Bracket LED Cradle
- (1) - Torx Bit T-40
- (4) - M8 Tamper Proof Bolt
- (4) - M8 x 16mm Button Head Allen Cap
Stainless Steel Bolts
- (4) - M8 Stainless Steel Hex Nuts
- (8) - 5/16" Flat Washers Black

TOOLS REQUIRED

- Various Socket Set
- Various Wrenches
- Ratchet Tool
- Ratchet Extensions

PAGE 1

INSTALLATION GUIDE

START HERE

PLEASE READ AND UNDERSTAND ALL INSTRUCTIONS BEFORE INSTALLATION. Auto makers offer varied models to each vehicle and occasionally manufacture more than one body style of the same model. To assure your part is correct; our tech department can be contacted at orders@zroadz.com to verify fitment and assist with technical questions. All other inquires can be directed to orders@zroadz.com. In the event you do not have internet access please call 844-653-8040

* APPLICATION MODELS VARY. WE RECOMMEND TO VERIFY FITMENT BEFORE BEGINNING INSTALLATION PROCESS.
* IMAGES FEATURED IN THE INSTRUCTION DOCUMENTS MAY NOT ALWAYS EXACTLY MATCH YOUR MODEL OR PART.

BEFORE YOU BEGIN

START HERE: Turn off engine, chalk tires with stop block, open the hood and disconnect the battery.

LED LIGHT BRACKET INSTALLATION

STEP 1 1) From under the rear bumper, take your ZROADZ LED light mount and mock it up into position. This will help you gain familiarity with the mounting orientation. Identify these two bolts that hang the rear bumper on either vehicle corner.



STEP 2

2) Using a Socket, or Wrench, loosen the two bolts about half way out.

Do not remove hardware. Only back out threads a few turns.

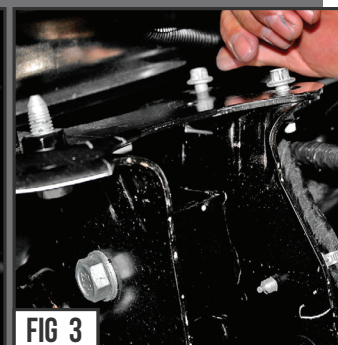
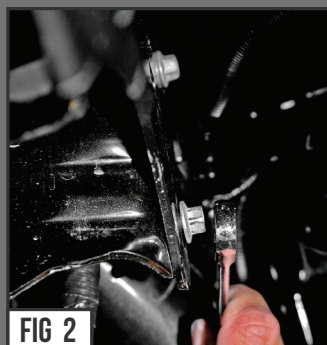

SEE FIGURES 2 & 3



ZROADZ

DYNAMIC LED MOUNTING SOLUTIONS

LED LIGHT BRACKET INSTALLATION - CONTINUED

PARTS ARE PATENT PENDING. ALL RIGHTS RESERVED - COPYRIGHT ©2016 - ZROADZ LED, INC.

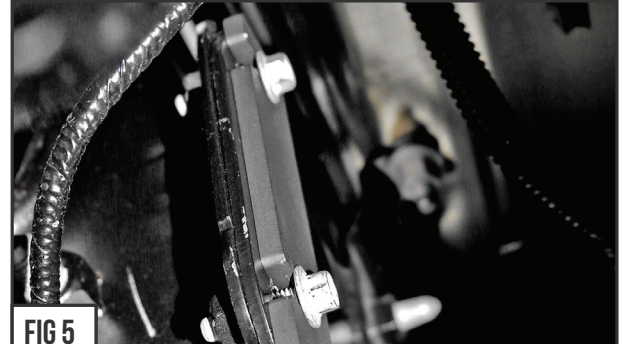
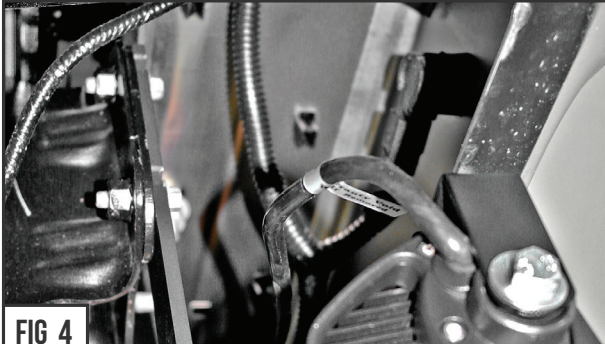

STEP 3

SEE FIGURE 4

3) Prop the LED bracket mounts into place by sliding mounting tab slots up and around the factory bolts. Make sure the brackets are on the back side of bumper mount and NOT in-between bumper and bumper mount. Repeat on opposite side of vehicle.

STEP 4

SEE FIGURES 5-8

4) Using your best judgement, move the adjustable bracket piece into your preferred position, and finally tighten everything up for now.

Look over your work and verify that the correct bracket has been mounted on the appropriate side of vehicle.

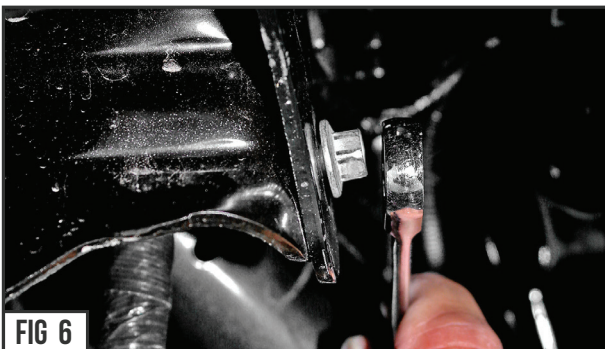

FINAL INSTALLATION

STEP 5

SEE FIGURE 5

Wire LED Light with a ZROADZ optional wiring harness kit (part# Z390020S-A) or by utilizing a compatible custom wiring harness. ZROADZ recommends LED Lights be wired with ZROADZ harness kit (part# Z390020S-A).



STEP 6 ADJUSTMENT TIPS

6) To adjust the angle of your Light Bar, rotate the LED(s) to adjust the angles till your desired light pattern is reached. You may then tighten the hardware and also mounting bracket and secure everything into place. Be careful not to over tighten the mounting hardware.

It is best to adjust the angle with the vehicle on level ground with lights facing a wall, garage door or other solid barrier. We recommend checking from a distance of 25'. Your installation is now completed.

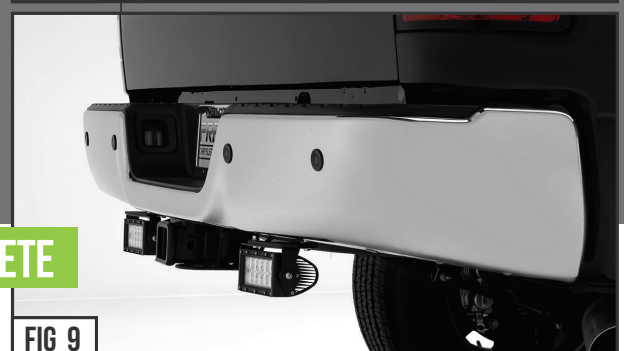

LED LIGHT BRACKET INSTALLATION - PROCESS COMPLETE



ZROADZ

DYNAMIC LED MOUNTING SOLUTIONS

ZROADZ PRODUCT WARRANTY

ZROADZ PRODUCT WARRANTY

ZROADZ warrants its grille products to be free from defects in material and workmanship for the lifetime of the grille. ZROADZ warrants the finish of its grille products for a 3 year period beginning at the time of sale to the end user. These warranties are limited warranties and do not cover abuse, modification or improper installation nor do they cover finish failure caused by caustic cleaning agents, road salts or other chemicals. ZROADZ reserves the right to repair or replace a defective product at its sole discretion. Any ZROADZ product must be returned to ZROADZ for warranty consideration and must be returned at the customer's expense. In the event that the product is deemed to be defective, the repaired or replaced item will be returned via a surface shipping method to the customer at ZROADZ expense. No provision is made for any labor, rental car or other costs incurred by the failure of its products.

LED LIGHTING EQUIPMENT INSTALLATION / DISCLAIMER

WARNING

PLEASE CONSULT YOUR LOCAL AUTOMOTIVE ELECTRICAL PROFESSIONAL FOR INSTALLATION SERVICES AND ADVICE. ZROADZ IS ONLY EQUIPPED TO PROVIDE BASIC TECHNICAL ASSISTANCE DUE TO THE DIVERSITY OF VEHICLES, VEHICLE OPTIONS & MODIFICATIONS AND LIGHTING CONFIGURATION OPTIONS AVAILABLE. ZROADZ cannot be held liable due to improper component installation and / or faulty wiring.

GENERAL GUIDELINES

LED Lights & LED Light Bars operate at relatively high currents and should only be installed by qualified personnel with experience in switched / relayed high draw DC Circuits.

- Light Bars are designed for use only with standard 12v DC power systems
- Light Bars are for OFF-ROAD USE ONLY. Check your local laws & regulations regarding vehicle mounted lights.
- Some Light Bars are equipped with waterproof connectors while others are simply pig-tailed
- Red Wires = POSITIVE | Black Wires = NEGATIVE
- ALWAYS install your lights on a fused circuit. Basic fusing guidelines: maximum 5A for every 10" of LED Light Bar.

GENERAL USE, INSTALL AND ADJUSTMENT TIPS

NOTE 1: ZROADZ LED Light Bars themselves are for OFF-ROAD USE ONLY.

NOTE 2: Light Bars depending on the configuration of your vehicle and its options and/or modifications may need to be adjusted for appropriate beam projection. To adjust the angle of your light bars simply loosen the mounting hardware on either side of each Light Bar, rotate the Light Bar to adjust the angle, then tighten the hardware once the desired angle is achieved (please be careful not to over-tighten the mounting hardware or scratch the protective powder-coat finish). It is best to adjust the angle with the vehicle on level ground with the lights facing a wall, garage door or other solid barrier at a distance of approximately 25-30 feet.

NOTE 3: Please consult a qualified automotive electrical professional for light bar wiring installation.

NOTE 4: An optional universal wiring harness (part# Z390020S-A) is also available that includes high-heat & oil/fuel resistant wires, waterproof connector, 12v relay, 12v rocker switch, inline fuse holder. Our universal wiring harness significantly expedites the installation process but is not a vehicles specific "Plug & Play" product and does not eliminate the need for a professional installation.

Please contact your local ZROADZ dealer for more information or visit www.ZROADZ.com.

PRODUCT CARE INFORMATION

PRODUCT CARE INFORMATION

Wash regularly as you would when caring for your vehicles. Never use dish soap. Never leave wet water spots as that may leave a blemish.

MATTE BLACK FINISH

Paint warranty applies to defects in material and / or workmanship, it does not cover the matte finish surface appearance.

To enjoy the matte appearance for many years to come, please follow these owner care and maintenance tips.

Get a no-shine matte car wash soap that uses no fillers, no silicone, and won't strip your matte paint of its layer of protection.

Do not use wax, detail spray, armorall®, or any products made for normal paint. Use only products specifically developed for matte finish paint. Do not use products that are even mildly abrasive, such as polishes, glazes, or rubbing compounds. Do not use mechanical cleaners or polishers. Do not use terrycloth, cloth, or paper towels. Do not rub the finish vigorously, this will burnish the paint finish, causing a permanent shiny spot. Shiny spots cannot be removed.

Do not use commercial car wash facilities or their shine enhancement products. Most car wash brushes, large mechanized "towels," and shine enhancement products can damage matte paint.

Remove foreign substances such as insect remains, tar, and road debris using a soft applicator and a mild solvent; saturate and soak area before cleaning—rub lightly.

Hand-wash with a soft wash mitt and mild cleaning product safe for matte paint. Use microfiber cleaning cloths with alcohol-based window cleaner for basic surface clean-up.

GLOSS BLACK FINISH

ZROADZ with Gloss Black Powder Coated Finish may be washed regularly as you would when caring for your vehicles finish using soap and water. ZROADZ should be waxed at the same time that you wax the vehicle. As a general rule, anything you use to clean your vehicles painted surfaces can be used to clean and maintain your ZROADZ. A Gloss powder Coated Finish can be cared for in the same fashion that you would care for your vehicles factory paint job. Never leave wet water spots as that may leave a blemish.

PARTS ARE PATENT PENDING. ALL RIGHTS RESERVED - COPYRIGHT ©2016 - ZROADZ LED, INC.