

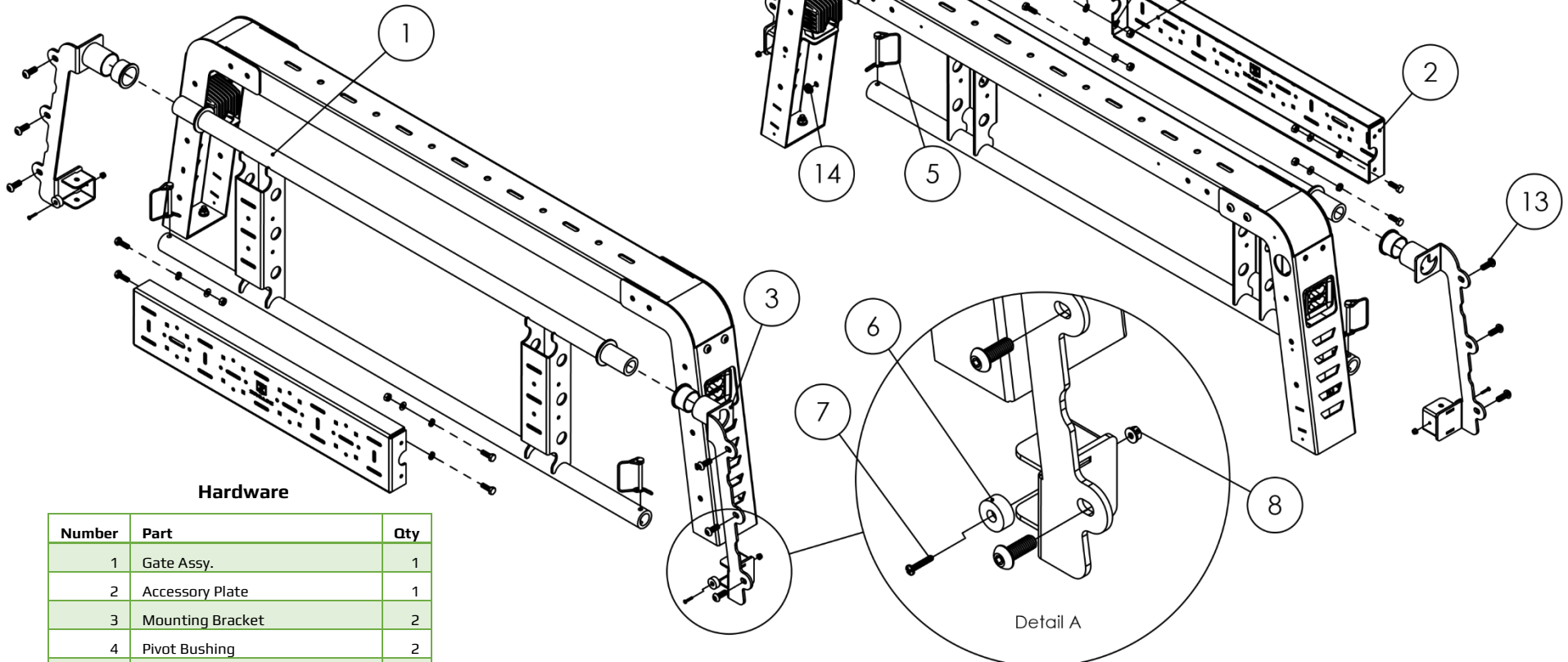

Access Overland Rack Rear Gate (Z835001) Installation Guide



Hardware

Number	Part	Qty
1	Gate Assy.	1
2	Accessory Plate	1
3	Mounting Bracket	2
4	Pivot Bushing	2
5	Steel Pin	2
6	Gate Bumper	2
7	6-32 x 1/2" Phillips Pan Screw	2
8	#6-32 SS Flange Nut	2
9	1/4" - 20 TPI X 1.00" Hex Bolt	4
10	1/4" Split Lock Washer	4
11	316 SS Flat Washer	4
12	1/4" Nut	4
13	3/8" x 1" Button Head Cap Screw	6
14	3/8" Flange Nut	6

Instructions

Before mounting any parts of the gate, assemble the gate and its hardware. Steps 1-4 describe how to assemble the gate.

1. Attach the Accessory Plate [2] to the Gate Assy. [1]. Use (4) 1/4" - 20 TPI X 1.00 Hex Bolt [9], (4) 1/4" Lock Washers [10], (4) SS Flat Washers [11] and (4) 1/4" Nuts [12].
2. As shown in Detail A, secure the Gate Bumpers [6] onto the Mounting Brackets' [3] receiving clamp. Use a 6-32 x 1/2" Phillips Pan Screw [7] and a #6-32 SS Flange Nut [8] on each side of the gate.
3. Install the Pivot Bushings [4] into the sleeves of each Mounting Bracket [3].
4. Install both the Mounting Brackets [3] onto the gate. Secure this attachment by locking the Steel Pins [5] between the lower tubing and the receivers.
5. Once the gate has been assembled, mount the gate onto the rack's legs using (6) 3/8" x 1" Button Head Screws [13] and (6) 3/8" Flange Nuts [14]. Begin by hand tightening the top screws and following with the ones below. As you go down, try to align the gate on both sides. Once finished, you will know the rack is appropriately aligned if it can operate as intended and both the Steel Pins [5] can move freely between the lower tubing and its clamp receivers.