



ZROADZ

DYNAMIC LED MOUNTING SOLUTIONS



PROFESSIONAL INSTALL RECOMMENDED

2017-2021 FORD F-250 / F-350

PART#: Z355471

REAR MODULAR / MULTI LED ROOF MOUNTS

PARTS ARE PATENT PENDING. ALL RIGHTS RESERVED - COPYRIGHT ©2017 - ZROADZ LED, INC.

PARTS INCLUDED

- (1) - Driver Side Rear Roof Mount Upright
- (1) - Passenger Side Rear Roof Mount Upright
- (1) - 55" Cross Member Tube
- (2) - "Z" End Caps
- (10) - Bracket Couplers
- (8) - Main Light Bracket Arms
- (4) - Rubber Boots
- (3) - Rubber Boot Plugs
- (2) - Rubber Gasket Base Grommets
 - (1) Drive Side & (1) Passenger Side
- (3) - Grommets
- (1) - Hardware Pack

LED LIGHTS INCLUDED

Z355471 - No LED Lights Included

HARDWARE INCLUDED

Z355471

- (2) - #10 Stainless Steel Nylock Nuts
- (2) - #10-32 x .625 Stainless Steel Button Head Allen Cap Screws
- (10) - 1/4-28 x 1.5 TPI Alloy Steel Full Thread Socket Cap Screws
- (2) - #10 -32 x .625 Stainless Steel Socket Cap Screws
- (60) - #10-32 x .5 Stainless Steel Button Head Allen Cap Screws
- (6) - M5 x .8 mm Hex Bolts
- (6) - M5 Washers
- (8) - M8 x 12 mm Tamper Proof Bolts
- (8) - M8 Split Lock Washers
- (3) - 5/16 DIA. Nylon Coated Wire Clip Mounts
- (1) - 1" T-40 TORX Bit

TOOLS REQUIRED

- Drill & Tapered Drill Bit
- Air Hose & Nozzle
- Alcohol Cleaning Solution
- Cleaning Rag
- Socket Set & Ratchet Tool
- Ratchet Extensions
- Various Wrenches
- Dikes or Snips
- Torq Bit Set
- Heat Gun

MATERIALS NEEDED - Clear RTV Silicone
- 1/2" x 1/4" DIA Shrink Tube

INSTALLATION GUIDE

START HERE

PLEASE READ AND UNDERSTAND ALL INSTRUCTIONS BEFORE INSTALLATION. Auto makers offer varied models to each vehicle and occasionally manufacture more than one body style of the same model. To assure your part is correct; our tech department can be contacted at orders@zroadz.com to verify fitment and assist with technical questions. All other inquires can be directed to orders@zroadz.com. In the event you do not have internet access please call 844-653-8040

* APPLICATION MODELS VARY. WE RECOMMEND TO VERIFY FITMENT BEFORE BEGINNING INSTALLATION PROCESS.
* IMAGES FEATURED IN THE INSTRUCTION DOCUMENTS MAY NOT ALWAYS EXACTLY MATCH YOUR MODEL OR PART.

BEFORE YOU BEGIN

LED LIGHT BRACKET INSTALLATION

IMPORTANT NOTE: The installation requires additional cutting and removal of material inside vehicle cab. The A-Pillar Air Bag will also need to be dropped and pushed aside. If you are not comfortable with this, stop installation and consult a professional.

START HERE: Turn off engine, chalk tires with stop block, open the hood and disconnect the battery.

STEP 1

- 1) First, Clean the base of the supplied roof brackets with alcohol. Apply the provided bottom plate gaskets.



STEP 2

SEE FIGURES 2 & 3

- 2) Make sure to align the gaskets so that the holes, down tube, and square opening are properly fitted with base plate to gasket.





ZROADZ

DYNAMIC LED MOUNTING SOLUTIONS

ROOF MOUNT INSTALLATION - CONTINUED

PARTS ARE PATENT PENDING. ALL RIGHTS RESERVED - COPYRIGHT ©2017 - ZROADZ LED, INC.



STEP 3

3) The ZROADZ Brackets have distinguished Passenger Side and Driver Side Uprights and could be noted by the brushed aluminum interior plate. The outside features the black powder coated steel plate with Logo Markings.

STEP 4

SEE FIGURE 5

4) Remove exterior trim piece that covers the vehicle cab seam to side.



REMOVE TRIM PIECE



STEP 4

SEE FIGURE 6

4) Start from the rear of the cab where the trim piece clips to a button.

STEP 5

SEE FIGURES 7-8-9

5) Gently pull the fastener loose and continue pry up and forward all the way to the front.

Note the very front of the vehicle cab is a forward facing tab the holds the trim piece down from the front.

Perform this step for both sides of the roof.



LED LIGHT ROOF MOUNT INSTALLATION - CONTINUED



ROOF MOUNT INSTALLATION - CONTINUED

PARTS ARE PATENT PENDING. ALL RIGHTS RESERVED - COPYRIGHT ©2017 - ZROADZ LED, INC.



FIG 10

STEP 6

SEE FIGURE 10

6) AT this point you will need to drop the interior roof upholstery.

INSTALLERS NOTE

This is a necessary and important step so that you can temporarily drop and push to the side the air bags and any other critical equipment stuffed up in between roof cab and the interior which will ensure critical components are not damaged.



FIG 11

STEP 7

SEE FIGURES 11 - 12

7) 2017 Ford F-250 / F-350 model vehicles feature an aluminum cab structure that is bolted together at the roof seam.

Starting on the Driver Side at the rear and working your way towards the front, remove first (6) bolts.



FIG 12

FIT ROOF MOUNT BRACKET



FIG 13

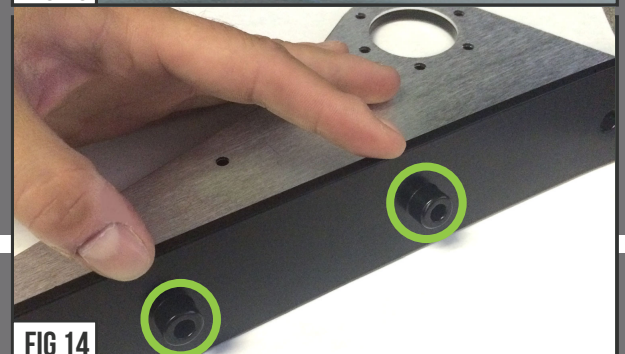

FIG 14

STEP 8

SEE FIGURES 13 - 14

8) The Upright and the down tube location will align with the vehicle cab bolt holes #2 and #3. With the bolts removed, use the tapered drill bit and bore out the bolt hole to a final diameter of 1/2" and just enough so that the down tube nub will fit snugly in place.

NOTE: This will also be required on the Vehicle Cab's Passenger Side.

STEPS 9

SEE FIGURES 15

9) With the hole drilled through, clean off all drilling debris and flash INSIDE AND OUTSIDE OF THE DRILL HOLE LOCATIONS. This is a very important to create a flush sealing surface and you do not want to leave any chance of rust occurring.



FIG 15

LED LIGHT ROOF MOUNT INSTALLATION - CONTINUED



ZROADZ

DYNAMIC LED MOUNTING SOLUTIONS

ROOF MOUNT INSTALLATION - CONTINUED

PARTS ARE PATENT PENDING. ALL RIGHTS RESERVED - COPYRIGHT ©2017- ZROADZ LED, INC.



STEP 10

SEE FIGURE 16

10) Double check the Bracket Mount is properly positioned and aligned with the vehicle cab bolt holes.

INSTALLERS NOTES

JUMP AHEAD TO STEPS #15 - #31. BEFORE PERMANENTLY ATTACHING BRACKETS AND APPLYING SILICONE TO THE VEHICLE ROOF, IT IS RECOMMENDED TO LOOSELY CONFIGURE LED LIGHTS & BRACKET MOUNTS TO THE PREFERRED POSITION WHILE MODULAR BAR IS OFF VEHICLE. ONCE MOD-BAR IS MOCKED UP, RETURN TO STEP #11 AND COMPLETE INSTALLATION.

STEP 11

SEE FIGURE 17

11) Dab a thin layer of clear RTV Silicone in and around the outside of each hole to help with weather proofing and sealing.

Proceed with securing the Bracket Mounts to Vehicle Cab by placing the provided Hex Bolts and Washers into position (exposed Vehicle Cab Bolt Holes).



CUT DOWN ROOF EXTERIOR TRIM PIECE

STEP 12

SEE FIGURE 18

12) Tighten down each Hex Bolt w/ Washer. Start at the front and then move to the back working your way towards the middle.

NOTE: Leave the last Hex Bolt somewhat loose to allow for Step # 14 to be completed.



STEPS 13 & 14

SEE FIGURES 19-21

13) Take the Vehicle's Exterior Trim Piece and hover it close to where the ZROADZ Bracket Mount Bottom Plate ends. Mark the Trim Piece so that when it is cut down, the Trim will fit back down into the Roof Channel.

14) Carefully and cleanly cut down the Trim Piece and then insert the provided Molding Plate into position as seen in Figure #21.

Put into position the Exterior Trim Piece so that it is secured under the Moulding Plate and re-attach all the fasteners.

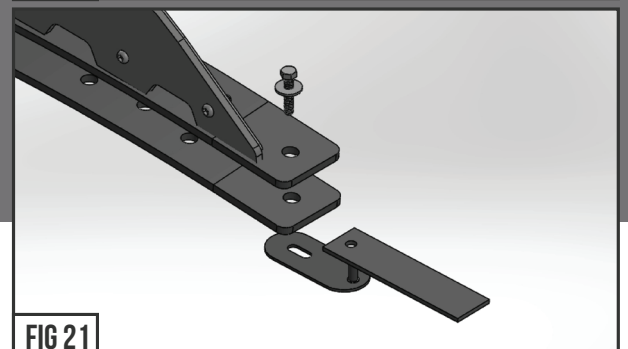
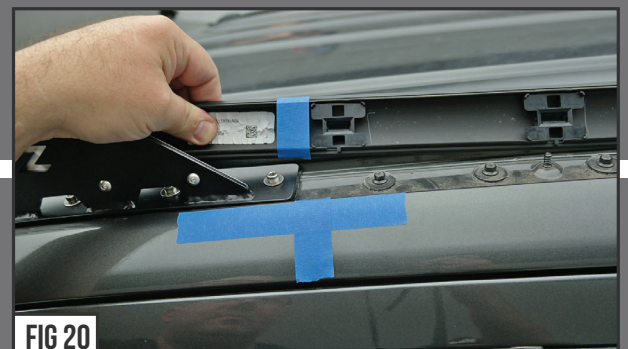

LED LIGHT ROOF MOUNT INSTALLATION - CONTINUED



MODULAR RACK ASSEMBLY - CONTINUED

PARTS ARE PATENT PENDING. ALL RIGHTS RESERVED - COPYRIGHT ©2016 - ZROADZ LED, INC.

INSTALLERS NOTE STEP 15

REMOVE ROOF BRACKETS UPRIGHTS FROM VEHICLE FOR COUPLERS & LEDS CONFIGURATION.

15) It is now time to begin assembly of the Upright Mounts with the couplers and bracket arms. Start with screwing the Steel Socket Caps into the Bracket Couplers as seen in Figure #22 & #23.

DO NOT BOTTOM OUT as you will need it adjustable.



FIG 22

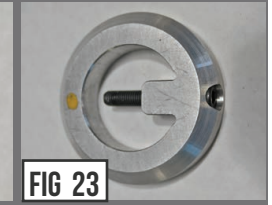

FIG 23

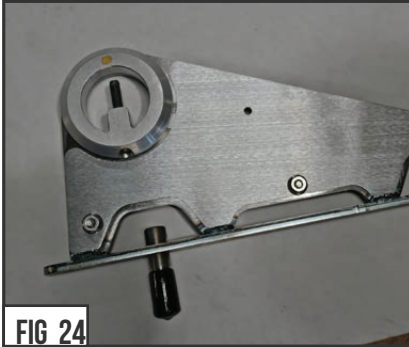

FIG 24



FIG 25



FIG 26

STEP 16

SEE FIGURES 24 - 26

16) Now fix a Bracket Coupler to the inside of the Upright Mounts using the #10-32 x .5 Button Head Allen Cap Screws. Make certain the Coupler is clocked as seen in Figures #24 & #26.

Repeat for the opposite side Upright Mount.

STEP 17

SEE FIGURES 27 - 30

17) At this time, go ahead and assemble at least 2 - 4 (or more) of the Bracket Assemblies. Some will be clocked straight with the Coupler Set Screw pointed to 12:00 o'clock, (Fig. #29) while some should be offset with the Set Screw pointed to 3:00 o'clock (Fig. #27).



FIG 27



FIG 28



FIG 29

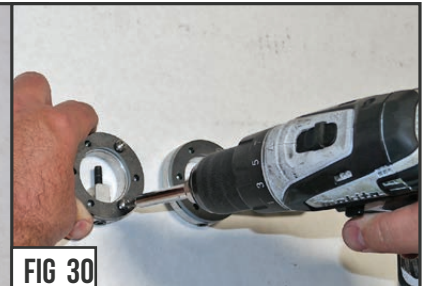

FIG 30

STEP 18

SEE FIGURE 31

18) Before you determine your light configuration you must determine the size and quantity of lights you plan to install. First measure the roof from the inside edge of the roof channel on the Driver Side, to the inside edge of the roof channel on the Passenger Side. This will give you your maximum allowable cross member mounting area to determine your light configurations.



FIG 31

STEP 19

SEE FIGURES 31 - 33

19) It is now time to mock up and determine your LED Light layout and configuration. Put the parts in place starting with the Cross Member Tube and Upright Mounts. Add and position LED Lights into your layout mock as you desire. Fit and match the Bracket Assemblies so that the layout resembles your preferred plan.

NOTE: Customize and build according to your needs and preference. There are literally dozens and dozens of configurable combinations to organize and stack LED Light Bar placement, facing forwards, backwards, left & right. Leave at least 1.5" Tube on each end

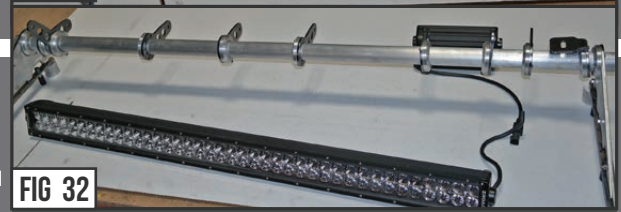

FIG 32



FIG 33

MODULAR RACK ASSEMBLY - CONTINUED



MODULAR RACK ASSEMBLY - CONTINUED

PARTS ARE PATENT PENDING. ALL RIGHTS RESERVED - COPYRIGHT ©2016 - ZROADZ LED, INC.

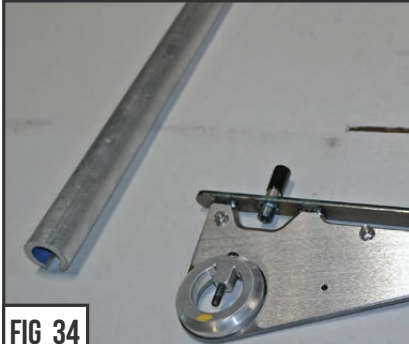

FIG 34



FIG 35

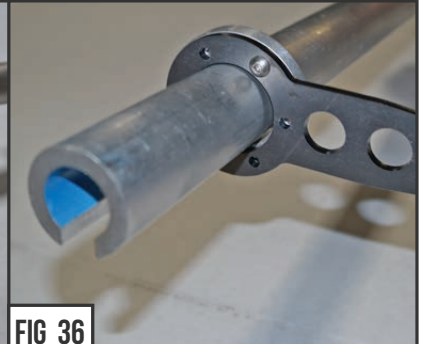

FIG 36

STEP 20

SEE FIGURES 34 - 39

20) With Your LED Light positioning determined and finalized, go ahead and slip the appropriate Bracket Assemblies onto the Cross Member Tube.

Make sure each bracket/coupler assembly is installed on the bar with the bracket and exposed button head Allen cap screws towards the outside of the LED light assembly as shown in Fig. # 17, 19.

STEP 21

SEE FIGURES 35 - 39

21) Fit and match the Bracket Assemblies so that the layout resembles your preferred plan.

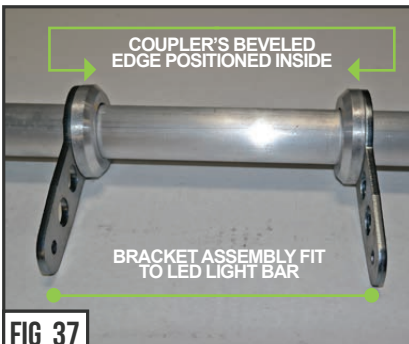

FIG 37

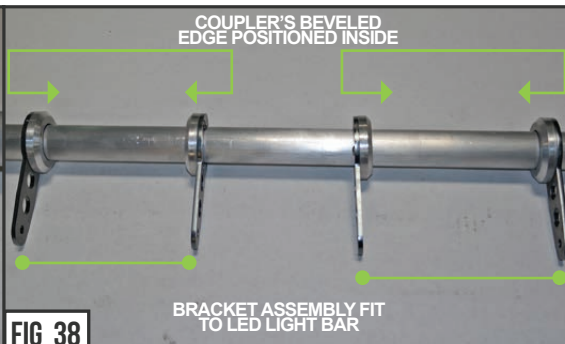

FIG 38

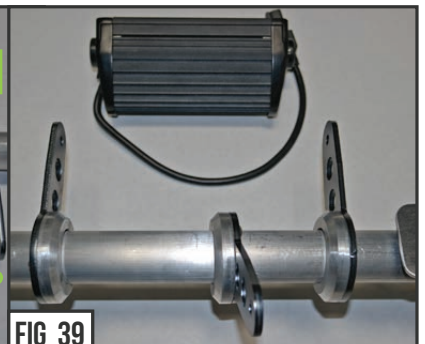

FIG 39

STEP 22

SEE FIGURES 39 & 40

22) Some Bracket Assemblies may be pointed forwards, backwards, and also clocked up if your original layout called out for this configuration.

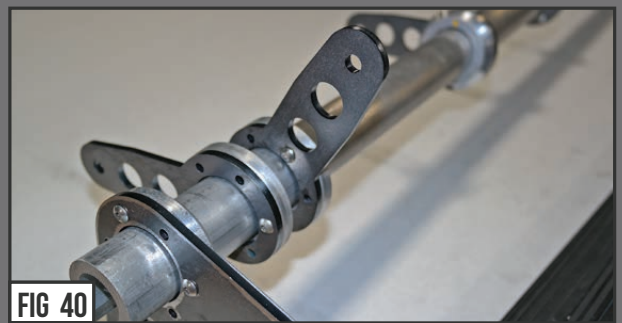

FIG 40

STEP 23

SEE FIGURES 41 - 43

23) Go ahead and mount the LED Lights into their designated position and secure to the Bracket Assemblies.

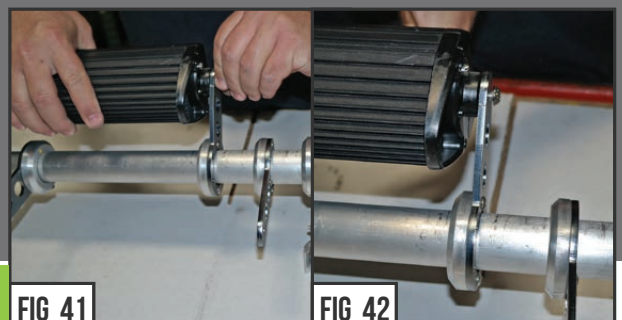

FIG 41

FIG 42

MODULAR RACK ASSEMBLY - CONTINUED



MODULAR RACK ASSEMBLY - CONTINUED

PARTS ARE PATENT PENDING. ALL RIGHTS RESERVED - COPYRIGHT ©2016 - ZROADZ LED, INC.



FIG 43



FIG 44



FIG 45

STEP 24

SEE FIGURE 44

24) With your LED Light positioning determined and finalized, go ahead and measure the LEDs placement side to side for approximate centering and equal symmetry.

STEP 25

SEE FIGURES 45 - 48

25) Once your satisfied with your LED placement, lock the Bracket Couplers into place by tightening the (Steel Thread Allen Cap) set screw on the underside of the Couplers.



FIG 46



FIG 47

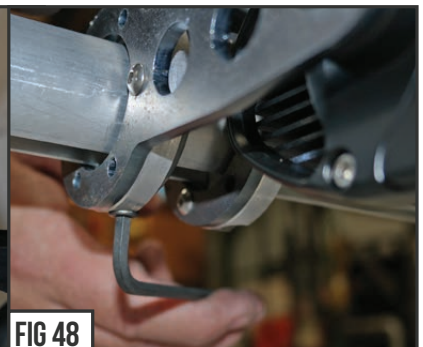

FIG 48

STEP 26

SEE FIGURES 49 - 54

26) It is now time to plumb and wire the LED Light Wiring inside the hollow cavern of the Cross Member Tube's under belly. Start by slipping the one of the 1/2" Rubber Sealing Washers (From Bag #6) onto each of the LED Light Wires.



FIG 49

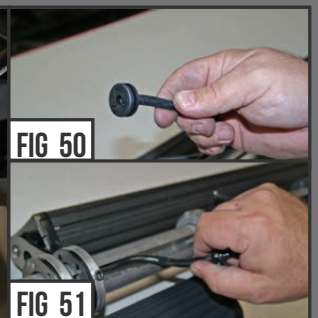

FIG 50

FIG 51

STEP 27

SEE FIGURES 49 - 54

27) To help push the rubber washer also the LED Light Wire into place, we recommend using some 50 / 50 water / dish soap lubricating solution to easily plumb the wires. With the 1/2" Rubber Sealing Washers slipped over the wires, carefully tuck it to the side of the Bracket Coupler's Set Screw. Press and insert the 1/2" Rubber Sealing Washers into the Cross Member Tube's Under Belly.



FIG 52



FIG 53

FIG 54

MODULAR RACK ASSEMBLY - CONTINUED



MODULAR RACK ASSEMBLY - CONTINUED

PARTS ARE PATENT PENDING. ALL RIGHTS RESERVED - COPYRIGHT ©2016 - ZROADZ LED, INC.



FIG 55



FIG 56



FIG 57

STEP 28

SEE FIGURES 55 - 57

28) The purpose of the 1/2" Rubber Sealing Washers around the LED Light wires is to hold and secure the wires inside the hollow cavern of the Cross Member Tube's under belly.

STEP 29

SEE FIGURE 56

29) Note that Modular Roof Mounts configured with an assortment of LED Lights will have multiple wires plumbed through the Cross Member Tube. For this reason, you may have to plumb some wires to the drivers side and some to the passenger side.

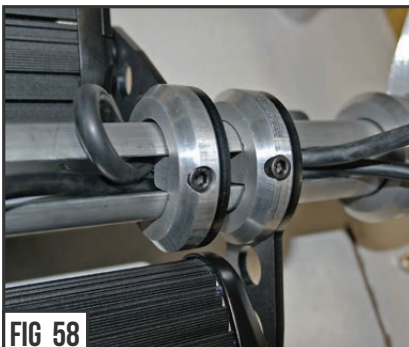

FIG 58



FIG 59

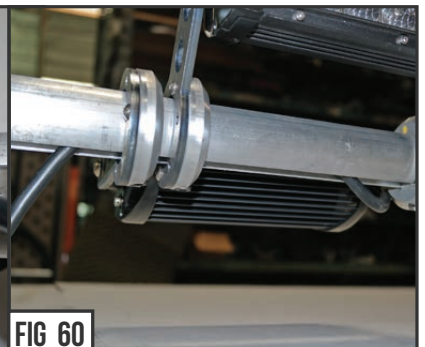

FIG 60

STEP 30

SEE FIGURES 58 - 50

30) If there is more than one wire, slip one wire to one side of the Set Screw and than slip the other wire to the other side of the set screw.

INSPECT YOUR WORK

The Bracket Assemblies should be locked into place, the LED Lights should be mounted, and the LED Light wires should be cleanly plumbed into the Cross Member Tube's under belly.



FIG 61

STEP 31

IMPORTANT

31) At this point, you will need to disassemble the Upright Mounts from the Assembled Modular Rack so you can accurately install the Upright Mounts onto Vehicle Roof. DO NOT attempt to install Upright Mounts with Assembled Modular Rack onto Vehicle Roof.

MODULAR RACK ASSEMBLY - COMPLETE



ROOF MOUNT INSTALLATION - CONTINUED

PARTS ARE PATENT PENDING. ALL RIGHTS RESERVED - COPYRIGHT ©2017 - ZROADZ LED, INC.

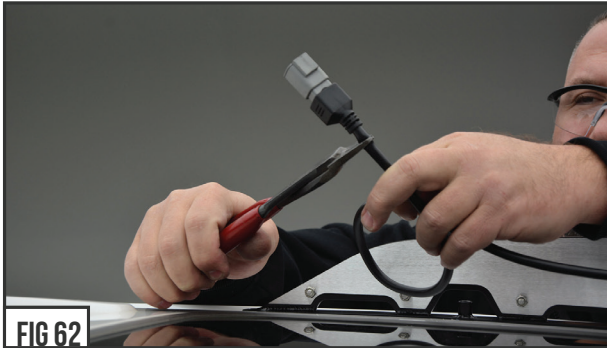

FIG 62



FIG 63

For your convenience we have supplied some simple tips for routing the LED Light Power wires through the weather proof boots.

STEPS 32

SEE FIGURE 62

32) Cut the LED light wires. Leave enough room for the insulation to be removed and the red and black wires to pass through the roof via the "Through Bolt Down Tube".

STEP 33

SEE FIGURE 63

33) Trim back a large amount of the insulation sheath off the LED Wires so that you can slip them through the rubber weather proofing boot.

To expose the wires, a sharp razor could easily splice open the insulation sheath.

WIRING PLUMBING



FIG 64

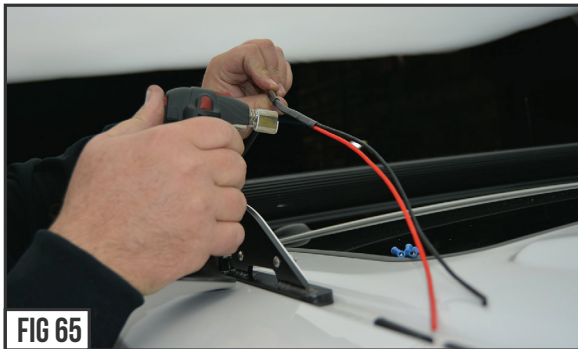

FIG 65

STEPS 34

SEE FIGURES 64 & 65

34) Install 1/4" heat shrink insulation over wires as shown in Figure #32. Shrink insulation with heat gun or similar.



FIG 66

STEPS 35

SEE FIGURES 66 - 69

35) Use a 50/50 mix of dish soap and water solution to install supplied boot over wire as shown in Figure #36.

Pass the wire through the tube. Use a liberal amount of solution on the bracket around the area where the boot installs to aid in slipping the boot over the post.

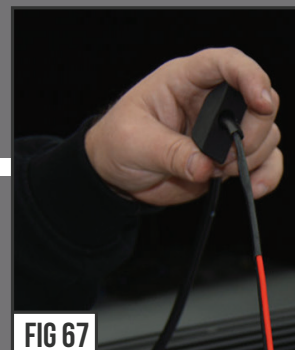

FIG 67



FIG 68

INSTALLERS NOTES

PROVISIONS NEED TO BE MADE TO ACCESS THE WIRES FROM THE BACK SIDE UNDERSIDE OF VEHICLE ROOF. THE WIRES WILL APPEAR HIDDEN DUE TO THE INNER CAB STRUCTURE. TO MAKE WIRES ACCESSIBLE, THIS MAY INCLUDE DRILLING ADDITIONAL HOLES OR CUTTING ACCESS POINTS FROM INSIDE THE CAB TO REACH THE WIRES.



FIG 69



ROOF MOUNT INSTALLATION - CONTINUED

PARTS ARE PATENT PENDING. ALL RIGHTS RESERVED - COPYRIGHT ©2017 - ZROADZ LED, INC.



FIG 70



FIG 71

STEPS 36

36) Stuff the boot into the bracket opening and over the down tube upright.

SEE FIGURE 70

STEP 37

37) With the rubber boot fully seated (as seen in Figures #70 & #71) you are now ready to finish wiring up the LED Light bar to a wiring harness.

SEE FIGURES 70 - 71

After wiring is complete, re-install vehicle's interior in the reverse order it was removed according to industry "R&R" method.

FINAL INSTALLATION



FIG 72



FIG 73



FIG 74

STEP 38

38) Wire LED Light with a ZROADZ optional wiring harness kit (part# Z390020S-A) or by utilizing a compatible custom wiring harness. ZROADZ recommends LED Lights be wired with ZROADZ harness kit (part# Z390020S-A).

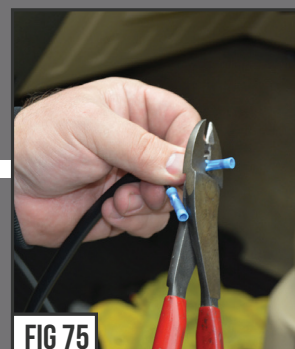

FIG 75

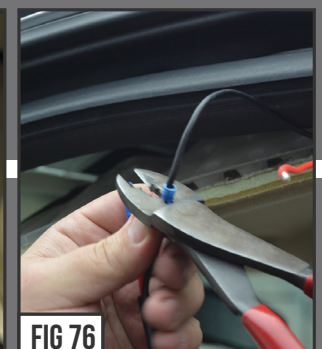

FIG 76

STEPS 39

ADJUSTMENT TIPS

39) To adjust the angle of your Light Bar, rotate the LED(s) to adjust the angles till your desired light pattern is reached. There will be minimal adjustment due to curved light bar orientation. You may then tighten the hardware and secure everything into place. Be careful not to over tighten the mounting hardware.

It is best to adjust the angle with the vehicle on level ground with lights facing a wall, garage door or other solid barrier. We recommend checking from a distance of 25'. Your installation is now completed.



FIG 77

LED LIGHT ROOF MOUNT INSTALLATION - COMPLETE



ZROADZ

DYNAMIC LED MOUNTING SOLUTIONS

ZROADZ PRODUCT WARRANTY

ZROADZ PRODUCT WARRANTY

ZROADZ warrants its grille products to be free from defects in material and workmanship for the lifetime of the grille. ZROADZ warrants the finish of its grille products for a 3 year period beginning at the time of sale to the end user. These warranties are limited warranties and do not cover abuse, modification or improper installation nor do they cover finish failure caused by caustic cleaning agents, road salts or other chemicals. ZROADZ reserves the right to repair or replace a defective product at its sole discretion. Any ZROADZ product must be returned to ZROADZ for warranty consideration and must be returned at the customer's expense. In the event that the product is deemed to be defective, the repaired or replaced item will be returned via a surface shipping method to the customer at ZROADZ expense. No provision is made for any labor, rental car or other costs incurred by the failure of its products.

LED LIGHTING EQUIPMENT INSTALLATION / DISCLAIMER

WARNING

PLEASE CONSULT YOUR LOCAL AUTOMOTIVE ELECTRICAL PROFESSIONAL FOR INSTALLATION SERVICES AND ADVICE. ZROADZ IS ONLY EQUIPPED TO PROVIDE BASIC TECHNICAL ASSISTANCE DUE TO THE DIVERSITY OF VEHICLES, VEHICLE OPTIONS & MODIFICATIONS AND LIGHTING CONFIGURATION OPTIONS AVAILABLE. ZROADZ cannot be held liable due to improper component installation and / or faulty wiring.

GENERAL GUIDELINES

LED Lights & LED Light Bars operate at relatively high currents and should only be installed by qualified personnel with experience in switched / relayed high draw DC Circuits.

- Light Bars are designed for use only with standard 12v DC power systems
- Light Bars are for OFF-ROAD USE ONLY. Check your local laws & regulations regarding vehicle mounted lights.
- Some Light Bars are equipped with waterproof connectors while others are simply pig-tailed
- Red Wires = POSITIVE | Black Wires = NEGATIVE
- ALWAYS install your lights on a fused circuit. Basic fusing guidelines: maximum 5A for every 10" of LED Light Bar.

GENERAL USE, INSTALL AND ADJUSTMENT TIPS

NOTE 1: ZROADZ LED Light Bars themselves are for OFF-ROAD USE ONLY.

NOTE 2: Light Bars depending on the configuration of your vehicle and its options and/or modifications may need to be adjusted for appropriate beam projection. To adjust the angle of your light bars simply loosen the mounting hardware on either side of each Light Bar, rotate the Light Bar to adjust the angle, then tighten the hardware once the desired angle is achieved (please be careful not to over-tighten the mounting hardware or scratch the protective powder-coat finish). It is best to adjust the angle with the vehicle on level ground with the lights facing a wall, garage door or other solid barrier at a distance of approximately 25-30 feet.

NOTE 3: Please consult a qualified automotive electrical professional for light bar wiring installation.

NOTE 4: An optional universal wiring harness (part# Z390029S-A) is also available that includes high-heat & oil/fuel resistant wires, waterproof connector, 12v relay, 12v rocker switch, inline fuse holder. Our universal wiring harness significantly expedites the installation process but is not a vehicles specific "Plug & Play" product and does not eliminate the need for a professional installation.

Please contact your local ZROADZ dealer for more information or visit www.zroadz.com.

PRODUCT CARE INFORMATION

PRODUCT CARE INFORMATION

Wash regularly as you would when caring for your vehicles. Never use dish soap. Never leave wet water spots as that may leave a blemish.

MATTE BLACK FINISH

Paint warranty applies to defects in material and / or workmanship, it does not cover the matte finish surface appearance.

To enjoy the matte appearance for many years to come, please follow these owner care and maintenance tips.

Get a no-shine matte car wash soap that uses no fillers, no silicone, and won't strip your matte paint of its layer of protection.

Do not use wax, detail spray, armorall®, or any products made for normal paint. Use only products specifically developed for matte finish paint. Do not use products that are even mildly abrasive, such as polishes, glazes, or rubbing compounds. Do not use mechanical cleaners or polishers. Do not use terrycloth, cloth, or paper towels. Do not rub the finish vigorously, this will burnish the paint finish, causing a permanent shiny spot. Shiny spots cannot be removed.

Do not use commercial car wash facilities or their shine enhancement products. Most car wash brushes, large mechanized "towels," and shine enhancement products can damage matte paint.

Remove foreign substances such as insect remains, tar, and road debris using a soft applicator and a mild solvent; saturate and soak area before cleaning—rub lightly.

Hand-wash with a soft wash mitt and mild cleaning product safe for matte paint. Use microfiber cleaning cloths with alcohol-based window cleaner for basic surface clean-up.

GLOSS BLACK FINISH

ZROADZ with Gloss Black Powder Coated Finish may be washed regularly as you would when caring for your vehicles finish using soap and water. ZROADZ should be waxed at the same time that you wax the vehicle. As a general rule, anything you use to clean your vehicles painted surfaces can be used to clean and maintain your ZROADZ grille. A Gloss powder Coated Finish can be cared for in the same fashion that you would care for your vehicles factory paint job. Never leave wet water spots as that may leave a blemish.